



MODELS | SJ6826 RT SJ6832 RT



COMPACT SERIES Rough Terrain SCISSOR LIFTS

Skyjack's Compact Series Rough Terrain Scissor Lifts offer the same industry leading rugged, robust, and reliable scissor lifts that have made Skyjack famous.

The SJ 6826RT and SJ6832RT both come equipped with an exclusive cross over symmetrical 4WD system for superior traction. Featuring up to 50% gradeability, these machines can operate on any job site terrain.

Standard features also include an easy to use 5' roll out extension deck, which can be secured in multiple positions for increased platform space and improved reach capabilities.

Both Compact models are drivable at full height with the roll out deck fully extended. An low stowed height is ideal for loading and unloading tools and materials.

Consistent with Skyjack's robust and reliable design features, the Compact Series Rough Terrain Scissor Lifts utilize Skyjack's standard color coded and numbered wiring system with analog based controls.



COMPACT SERIES

Rough Terrain Scissor Lifts

Specifications	SJ6826 RT	SJ6832 RT
A Work Height	32' (9.8 m)	38' (11.6 m)
B Raised Platform Height	26' (7.92 m)	32' (9.8 m)
C Lowered Platform Height	48.5" (1.2 m)	54" (1.4 m)
D Overall Width	68" (1.7 m)	68" (1.7 m)
E Overall Length	107" (2.7 m)	107" (2.7 m)
F Stowed Height (Rails Up)	93.5" (2.4 m)	99" (2.5 m)
G Stowed Height (Rails Down)	63.5" (1.6 m)	69" (1.8 m)
H Platform Width (Inside Dimension)	56" (1.4 m)	56" (1.4 m)
I Platform Length (Inside Dimension)	96" (2.4 m)	96" (2.4 m)
Deck Extension	5' (1.5 m)	5' (1.5 m)
Ground Clearance	8" (0.2 m)	8" (0.2 m)
Wheelbase	80.5" (2.0 m)	80.5" (2.0 m)
Weight	6,400 lbs (2903 kg)	7,660 lbs (3475 kg)
Gradeability	50%	40%
Turning Radius (Inside)	60" (1.5 m)	60" (1.5 m)
Turning Radius (Outside)	156" (4.0 m)	156" (4.0 m)
Lift Time (With Rated Load)	36 sec	39 sec
Drive Speed (Stowed)	3.8 mph (6.1 km/h)	3.8 mph (6.1 km/h)
Drive Speed (Raised)	0.4 mph (0.6 km/h)	0.4 mph (0.6 km/h)
Maximum Drive Height	Full Height	Full Height
Capacity (Overall)	1,250 lbs (567 kg)	1,000 lbs (454 kg)
Maximum # of Persons	4	4

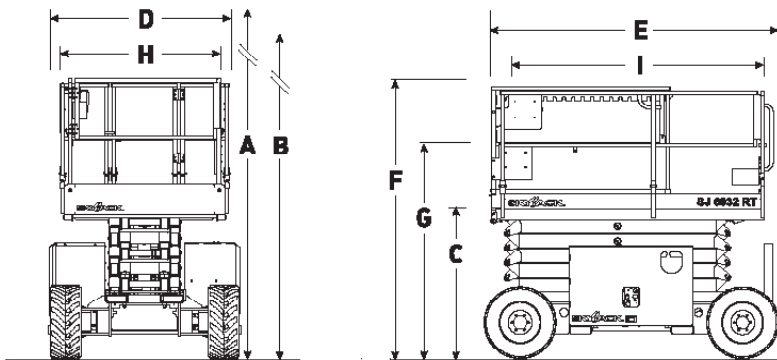

STANDARD FEATURES

- Drivable at full height with roll out deck fully extended
- Crossover symmetrical 4WD
- Multiple wet disc spring applied hydraulic release brakes
- 5' (1.5 m) roll out extension deck
- 31hp Kubota Dual fuel (gas/propane) engine
- 90° swing out engine tray
- Analog control system
- Color coded and numbered wiring system
- Up to 50% Gradeability
- Foam-filled low profile grip lug tires
- 110V AC outlet on platform with GFI
- Tilt alarm with drive & lift cut-out
- All motion audible alarm
- Operator horn
- Hinged railing system
- Full height spring hinged gate at rear of unit
- Lanyard attachment points
- Forklift pockets and tie down/lift lugs

OPTIONS†

- 24hp Kubota Diesel engine (in lieu of std dual fuel)
- Diesel engine with scrubber (in lieu of std dual fuel)
- Independent/auto leveling outriggers
- Flashing light
- Shop airline to platform
- 2000W hydraulic generator
- Extra propane tank and bracket (dual fuel only)
- Air-filled tires (6826RT only)
- Air-filled tires with tire sealant (6826RT only)
- Foam-filled non marking tires (6826RT only)
- Solid rubber non marking tires

† Capacities, and machine weights may differ when options are added

Skyjack Head Office

55 Campbell Rd. Guelph, ON Canada N1H 1B9
 Sales Inquiries: 1-877-755-4387 (1-877-SJLIFTS)
 Main Switchboard: 1-800-265-2738
 Phone: 519-837-0888
 Fax: 519-837-8104
 Email: skyjack@skyjack.com

www.skyjack.com

This brochure is for illustrative purpose only and based on the latest information at the time of printing. Skyjack Inc. reserves the right to make changes at any time, without notice, to specifications, standard and optional equipment. Consult the Operating Maintenance and Parts Manuals for proper procedures. Work platforms have been tested to comply with ANSI and CSA standards as interpreted by Skyjack, Inc.